



Description & Features:

- Quality series for all sanitary gauge systems
- Food grade glycerin filling standard
- Electro-polish finish
- Industrial grade polycarbonate lens standard
- Clean-In-Place and steam-in-place design
- 0.75", 1.5" and 2" Tri-Clamp® connection bottom and back
- ASME B40.100 compliant
- CRN registered
- 5 year warranty

Applications:

- Designed for all sanitary applications including food & beverage, dairy, pharmaceutical and biotechnical
- Built to withstand the harshest of sanitary applications and where 3A approval is required
- For gas, air, liquid, pasty or powdery media

Specifications

Dial	2.5" (63mm), 4" (100mm) aluminum
Case	304 SS, polished
Bezel	304 SS, polished
Lens	Polycarbonate
Over Pressure Limit	25% up to 600 psi (41 bar) 15% over 600 psi (41 bar)
CIP Temperature Limit	250°F (121°C) continuous
SIP Temperature Limit	266°F (130°C) 1 hour, dry
Bourdon Tube	316 SS
Socket	316 SS
Movement	304 SS
Enclosure Rating	IP65/NEMA 4X
System Fill	Food grade glycerin standard (Mineral oil, silicone and Neobee-20 optional)
Case Fill	Food grade glycerin standard (Dry, mineral oil, silicone and Neobee-20 optional)
Re-zero Feature	Adjustable micrometer pointer (4" (100mm) dial only)
Wetted Parts	316L SS, Ra = 8 microinches
Ambient Temperature	Glycerin filled: 40°F to 150°F (4°C to 65°C)
Process Temperature	0°F to 250°F (-18°C to 121°C)
Accuracy	2.5" (63mm): ±1.5% of full scale 4" (100mm): ±1.0% of full scale
Agency Compliance	3A standard 74-07

Order Codes (products in bold are normally stock in North America)

Dial Size	2.5" (63mm)						4" (100mm)			
Tri-Clamp® Connection	0.75" (20mm) Bottom	0.75" (20mm) Back	1.5" (40mm) Bottom	1.5" (40mm) Back	2" (50mm) Bottom	2" (50mm) Back	1.5" (40mm) Bottom	1.5" (40mm) Back	2" (50mm) Bottom	2" (50mm) Back
30" Hg Vac/bar	PSQ34797	PSQ34797B	PSQ15797	PSQ15797B	PSQ20797	PSQ20797B	PSQ15202	PSQ15202B	PSQ20120	PSQ20120B
30"/0/30 psi/bar	PSQ34798	PSQ34798B	PSQ15798	PSQ15798B	PSQ20798	PSQ20798B	PSQ151021	PSQ151021B	PSQ201021	PSQ201021B
30"/0/60 psi/bar	PSQ34799	PSQ34799B	PSQ15799	PSQ15799B	PSQ20799	PSQ20799B	PSQ151022	PSQ151022B	PSQ201022	PSQ201022B
30"/0/100 psi/bar	PSQ34791	PSQ34791B	PSQ15791	PSQ15791B	PSQ20791	PSQ20791B	PSQ151023	PSQ151023B	PSQ201023	PSQ201023B
30"/0/150 psi/bar	PSQ34793	PSQ34793B	PSQ15793	PSQ15793B	PSQ20793	PSQ20793B	PSQ151025	PSQ151025B	PSQ201025	PSQ201025B
30"/0/200 psi/bar	PSQ34794	PSQ34794B	PSQ15794	PSQ15794B	PSQ20794	PSQ20794B	PSQ151026	PSQ151026B	PSQ201026	PSQ201026B
30"/0/300 psi/bar	PSQ34795	PSQ34795B	PSQ15795	PSQ15795B	PSQ20795	PSQ20795B	PSQ151027	PSQ151027B	PSQ201027	PSQ201027B
0/30 psi/bar	PSQ34802	PSQ34802B	PSQ15802	PSQ15802B	PSQ20802	PSQ20802B	PSQ15602	PSQ15602B	PSQ20602	PSQ20602B
0/60 psi/bar	PSQ34803	PSQ34803B	PSQ15803	PSQ15803B	PSQ20803	PSQ20803B	PSQ15603	PSQ15603B	PSQ20603	PSQ20603B
0/100 psi/bar	PSQ34804	PSQ34804B	PSQ15804	PSQ15804B	PSQ20804	PSQ20804B	PSQ15604	PSQ15604B	PSQ20604	PSQ20604B
0/160 psi/bar	PSQ34805	PSQ34805B	PSQ15805	PSQ15805B	PSQ20805	PSQ20805B	PSQ15605	PSQ15605B	PSQ20605	PSQ20605B
0/200 psi/bar	PSQ34806	PSQ34806B	PSQ15806	PSQ15806B	PSQ20806	PSQ20806B	PSQ15606	PSQ15606B	PSQ20606	PSQ20606B
0/300 psi/bar	PSQ34807	PSQ34807B	PSQ15807	PSQ15807B	PSQ20807	PSQ20807B	PSQ15607	PSQ15607B	PSQ20607	PSQ20607B
0/600 psi/bar	PSQ34808	PSQ34808B	PSQ15808	PSQ15808B	PSQ20808	PSQ20808B	PSQ15608	PSQ15608B	PSQ20608	PSQ20608B
0/1,000 psi/bar	PSQ34809	PSQ34809B	PSQ15809	PSQ15809B	PSQ20809	PSQ20809B	PSQ15609	PSQ15609B	PSQ20609	PSQ20609B

Other ranges and connection sizes available upon request. For scale change, refer to How to Order Guide for scale codes.

**2.5" Bottom Connection
0.75" Tri-Clamp®**

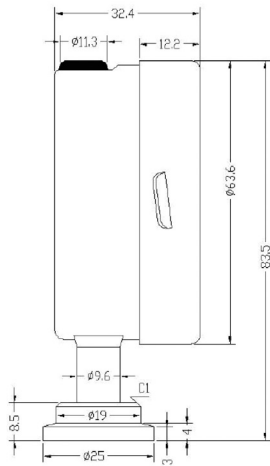

**2.5" Bottom Connection
1.5" Tri-Clamp®**

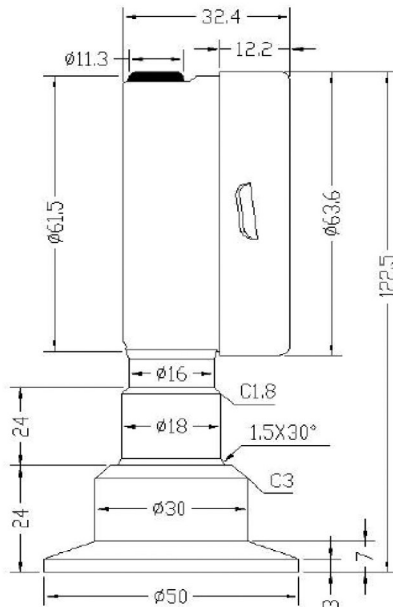

**2.5" Bottom Connection
2" Tri-Clamp®**

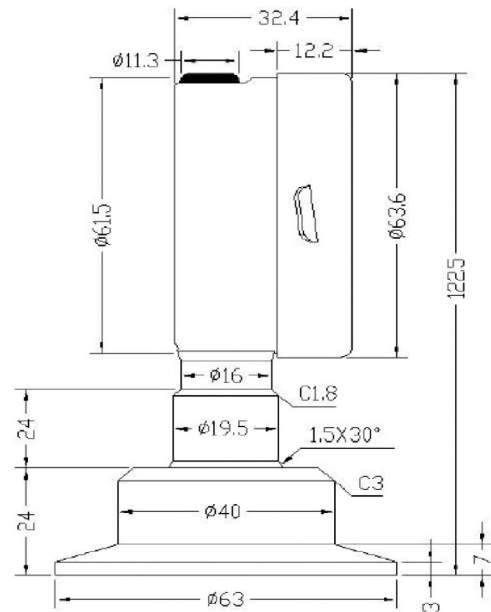

Tri-Clamp® is a registered trade mark of Tri-Clover

2.5" Back Connection 0.75" Tri-Clamp®

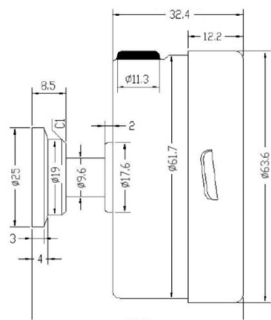

2.5" Back Connection 1.5" Tri-Clamp®

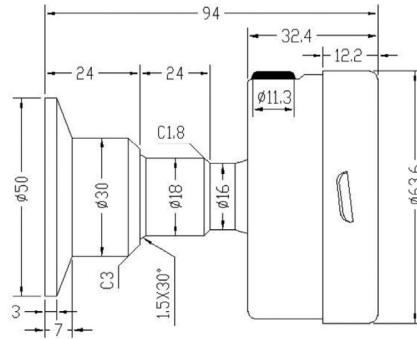

2.5" Back Connection 2" Tri-Clamp®

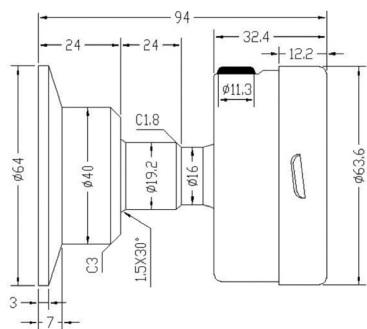

4" Bottom Connection 1.5" Tri-Clamp®

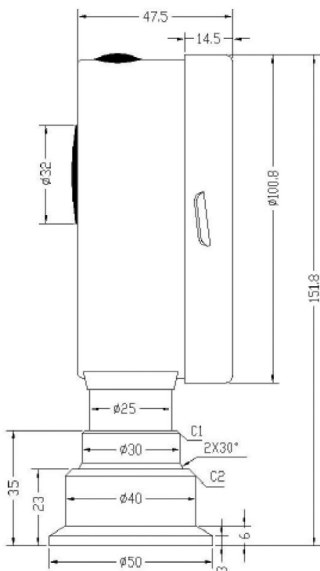

4" Bottom Connection 2" Tri-Clamp®

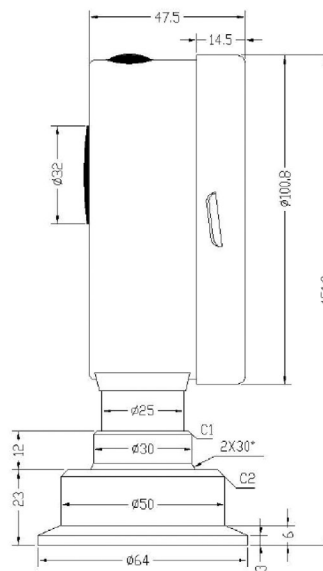

4" Back Connection 1.5" Tri-Clamp®

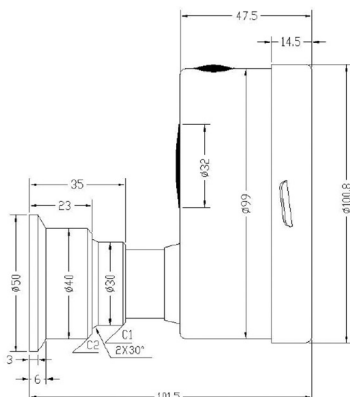

4" Back Connection 2" Tri-Clamp®

